



Shipping & Mailing
Printing

AddressRight® 200

Address Printer

User Guide

US English Edition
SV63324 Rev. C
March 05, 2020

©2020 Pitney Bowes Inc.

All rights reserved. This book may not be reproduced in whole or in part in any fashion or stored in a retrieval system of any type or transmitted by any means, electronically or mechanically, without the express written permission of Pitney Bowes.

The use of this information by the recipient or others for purposes other than the training of customers on Pitney Bowes equipment may constitute an infringement of intellectual property rights of Pitney Bowes, and Pitney Bowes assumes no responsibility for any such use of the information.

We have made every reasonable effort to ensure the accuracy and usefulness of this manual. However, we cannot assume responsibility for errors or omissions or liability for the misuse or misapplication of our products.

Except as provided in writing, duly signed by an officer of Pitney Bowes, no license either express or implied, under any Pitney Bowes or third party's patent, copyright or other intellectual property rights is granted by providing this information.

Table of Contents

1 - Getting Started

| | |
|---|----|
| Front View | 6 |
| Rear View | 7 |
| Control Panel | 8 |
| Power Button | 9 |
| Using the Touchscreen | 10 |
| Entering the Network Settings | 12 |
| Connecting the Printer to a Wi-Fi Network | 12 |

2 - Operating the Printer

| | |
|------------------------------------|----|
| Adjusting the Horizontal Alignment | 15 |
| Adjusting the Vertical Alignment | 15 |
| Adjusting the Print Job Properties | 16 |
| Checking Ink Status | 22 |
| Estimating Ink Usage | 23 |
| Selecting the Ink Type | 25 |
| Selecting the Language | 26 |

3 - Menus and Options

| | |
|--------------------------|----|
| Quick Menu | 29 |
| Main Menu | 30 |
| Info Menu | 31 |
| Print Data Menu | 32 |
| Print Image Screen | 33 |
| Printer Preferences Menu | 35 |
| Printer Setup Menu | 37 |
| Tools Menu | 38 |

| | |
|-----------------------------|----|
| Time Server (Date and Time) | 39 |
| Wireless Status | 40 |

4 - Maintenance

| | |
|--|----|
| Calibrating the Touchscreen | 42 |
| Cleaning the Printer | 42 |
| Cleaning the Printhead | 44 |
| Inkjet Cartridges | 45 |
| Printer Jams | 47 |
| Purging the Nozzles | 47 |
| Replacing the Inkjet Cartridges | 48 |
| Replacing the Metering Segments (Sheet Separators) | 49 |
| Restoring Factory Defaults | 51 |
| Running Diagnostics | 51 |

5 - Specifications

| | |
|------------------------|----|
| Printer Specifications | 54 |
|------------------------|----|

6 - Contacting Pitney Bowes

| | |
|-------------------------|----|
| Contacting Pitney Bowes | 57 |
|-------------------------|----|

7 - Safety

| | |
|-----------------------|----|
| Product Documentation | 59 |
|-----------------------|----|

1 - Getting Started

In this section

| | |
|---|----|
| Front View | 6 |
| Rear View | 7 |
| Control Panel | 8 |
| Power Button | 9 |
| Using the Touchscreen | 10 |
| Entering the Network Settings | 12 |
| Connecting the Printer to a Wi-Fi Network | 12 |

Front View

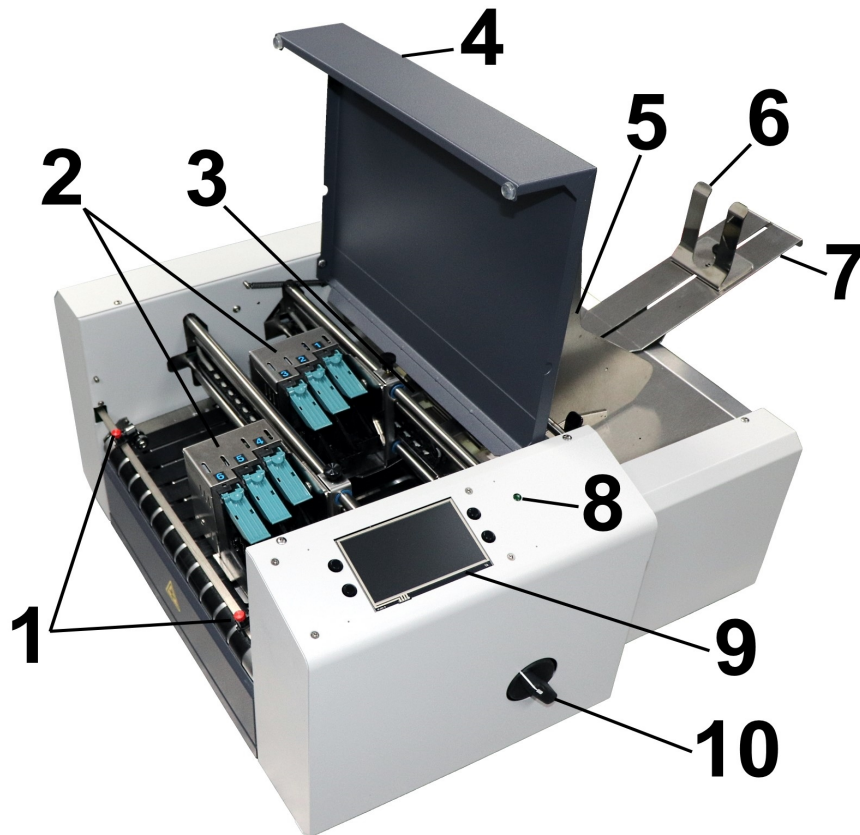

1. **Exit Guides:** Help media to exit printer
2. **Printhead Assembly:** Has 6 printheads arranged on two rails and can print an image up to 3" wide
3. **Media Sensor:** Senses media as it enters the printhead area. Located behind printhead assembly.
4. **Top Safety Cover:** Encloses the printheads
5. **Media Side Guides:** Position media in printer
6. **Rear Media Guide:** Holds media against front plate
7. **Rear Media Support:** Supports media while it is being fed
8. **Power Indicator Light:** Shows that the main power is on

9. **Control Panel Touchscreen:** Displays printer menus and controls to set up and operate the printer. Also has four control buttons to access or operate frequently used printer functions: Quick Menu, Power Off/Reset, Transport ON/OFF, and Feeder ON/OFF.
10. **Media Thickness Adjustment Knob:** Adjusts height of printheads to compensate for different media thicknesses.

Rear View

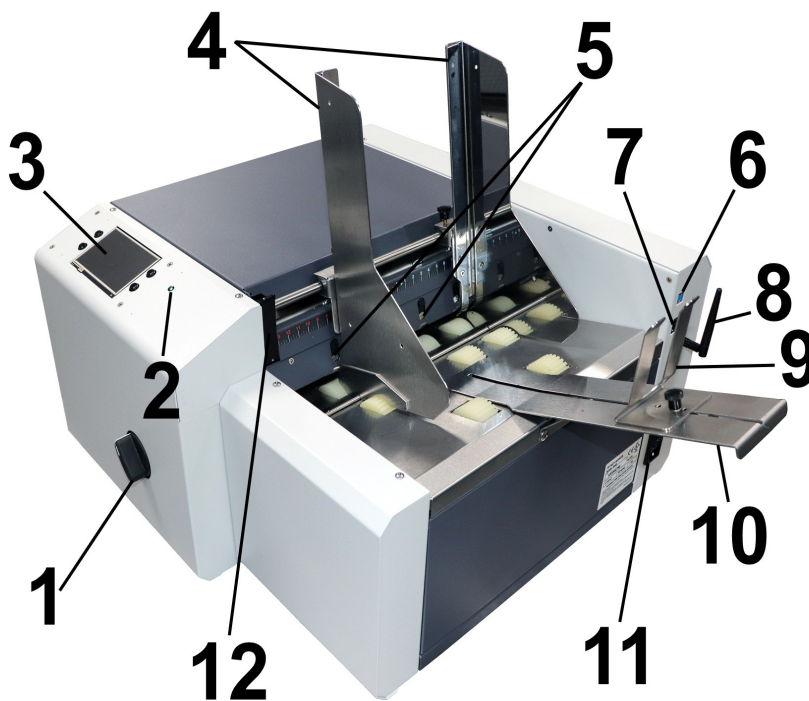

1. **Media Thickness Adjustment Knob:** Adjusts the height of the printheads to compensate for different media thicknesses
2. **Power Indicator Light:** Shows that the main power is on
3. **Control Panel Touchscreen:** Touchscreen to access printer menus for printer setup and operation, and buttons to access Quick Menu, Power Off/Reset, Online/Offline, and Pause/Print.
4. **Media Side Guides:** Position media in the printer
5. **Sheet Separators:** Adjustable to ensure proper tension with the feed rollers for different media thicknesses. There are four separators to handle different media widths.
6. **USB 3.1 Port:** Connects the printer to your computer (also supports USB 2.0)
7. **Ethernet Port:** Connects the printer to a network

8. **Wi-Fi Port:** Connect Wi-Fi antenna (included) to monitor or operate the printer wirelessly through your network
9. **Rear Media Guide:** Holds media against the front plate
10. **Rear Media Support:** Supports media while it is being fed
11. **Main Power Switch, Power Receptacle and Fuse:** The power cord plugs in here. The window panel shows what voltage the printer is set for: 115V or 220V. The switch turns the printer on and off. The fuse protects the motor from overloads.



Caution: Double pole/neutral fusing. For continued protection against risk of fire, the fuse should only be replaced by qualified service personnel.

12. **Separator Locking Lever:** Unlocks/locks Sheet Separators to adjust separators for different types of media

Control Panel



1. **Quick Menu button:** Quick access to the following frequently-used printer functions: Test Feed/Reprint, Horizontal and Vertical Alignment, Printer Preferences, Purge Print, and Ink Status. Press to open. Press the **Quick Menu** button again to exit the screen.
2. **Power Off/Restart button:** The **Shutdown Printer** screen opens with the following options: Restart, Shutdown, USB Disconnect, Sleep Now, Port Reset, and Cartridge Initialize. **Shutdown** closes printer functions safely before turning off printer power with the main power switch.

3. **Transport On/Off button:** Turns the transport motor on and off. Press to turn the transport off. Also used to temporarily run the transport to clear media from under the printheads.
4. **Feeder On/Off button:** Turns the feeder on and off. Provides a quick way to print and pause a job at the printer without using the touchscreen or computer. Press to start printing. Press to pause a running job. Press again to resume printing. After pausing a job, pressing this button starts both the feeder and the transport.
5. **Control Panel touchscreen:** Use the touchscreen arrow and screen icons to operate the printer and set and adjust printer settings and functions. Also check printer status and error messages.

Related topics

- [Quick Menu on page 29](#)
- [Power Button below](#)
- [Using the Touchscreen on the next page](#)

Power Button

Press the **Power Off/Restart** button on the Control Panel to open the Shutdown Printer screen.



The following functions are found on this screen:

Restart: Stops and restarts the printer's software and electronics

Shutdown: Safely shuts down the software and turns off the printer. Once the printer turns off, you can safely turn the main power switch off.

USB Disconnect: Disconnects or reconnects the printer communication with the USB port

Sleep Now: Puts the printer into sleep mode. Wakes when the touchscreen is touched or a job is sent to the printer through the USB or network.

Port Reset: Clears any jobs being sent to the printer. This is used when, after a job has been canceled at the printer, the remainder of the job continues to be sent by the computer, which can cause the printer to get stuck because it can no longer read the job. Usually, once the Power Off/Reset button on the Control Panel is pressed, this happens automatically and the Port Reset button is inactive. If the Port Reset button is still active, you can press it to fully clear the job.

Cartridge Initialize: Reestablishes communication between the printhead cartridges and the printer

Using the Touchscreen

The Control Panel touchscreen turns on when the printer is turned on. Use the touchscreen and printer Control Panel buttons to access various functions that help you control or customize printer operation.

Basic Touchscreen Information

Tap the **Green Arrow** to return to the previous screen.

Tap the **Help (Life Preserver)** icon to open a short description of the features found on that screen.

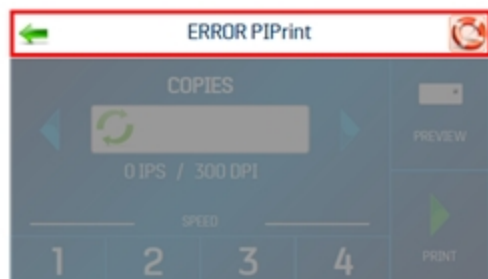

Using the Touchscreen Keyboards

Use the touchscreen keyboards when entering or editing information in entry boxes. The appropriate keyboard opens when you tap on an input box or tap within a data entry box on the touchscreen.

- Tap the **C** to the left of the white entry box to clear the box.

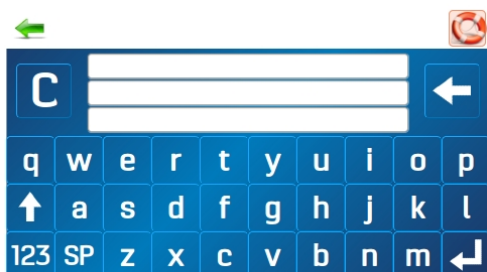

- Tap the **Arrow** to the right of the white entry box to delete the last character entered.
- Tap the **Enter Arrow** in the lower right to save your entry.
- Tap the **Up Arrow** to toggle between upper and lower case letters.
- Tap **SP** (space bar) to type a space.
- Tap **123** to open the numeric keyboard.

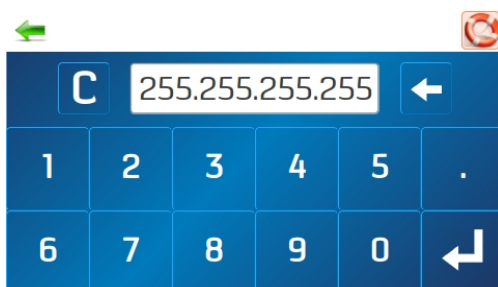

- Tap **#+=** on the numeric screen to open the symbols keyboard.

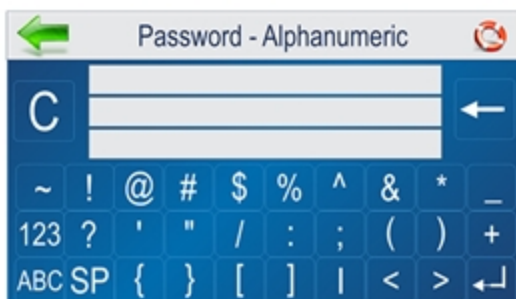

Entering the Network Settings

1. Tap **Network** on the **Tools** screen to open the Network Settings screen.
2. Select **Network Setup** to enter the settings for connecting the printer to your network.

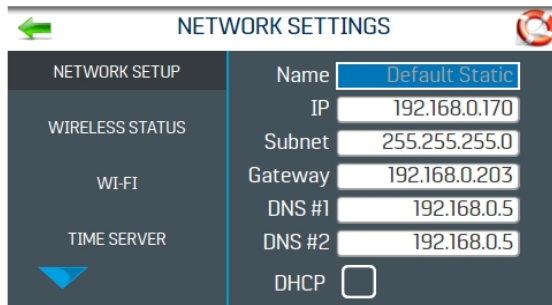

3. Enter the printer name, IP address, Subnet address, Gateway address, DNS #1, and DNS #2, and select or deselect **DHCP** as needed. Your IT or Network department may be needed to help with this step.
4. Tap **Refresh** to refresh/update the network connection.

Related topics

- [Connecting the Printer to a Wi-Fi Network below](#)

Connecting the Printer to a Wi-Fi Network

1. Connect the Wi-Fi antenna (included) to the printer's Wi-Fi port.
2. Tap **Network** on the **Tools** screen to open the Network Settings screen.
3. Tap **WI-FI**.
4. Select the desired network from the **Wi-Fi Networks** list .

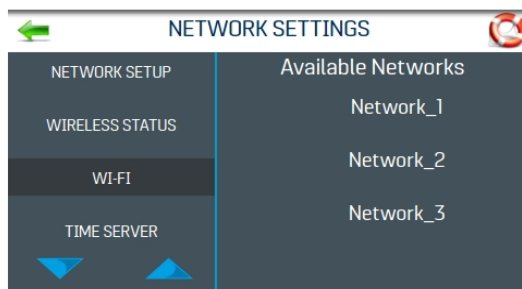

5. Enter the network **ID** and **Password** and tap **OK**.

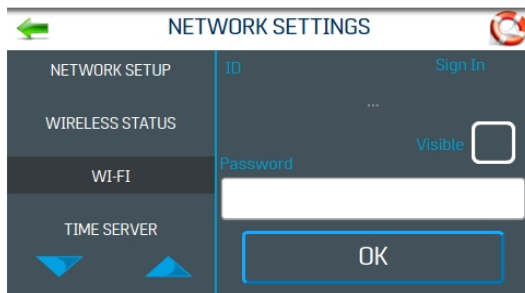

6. The screen will show if you are connected to the network. If the connection fails, try again. Verify that you are connecting to the correct network and using the correct ID and password.

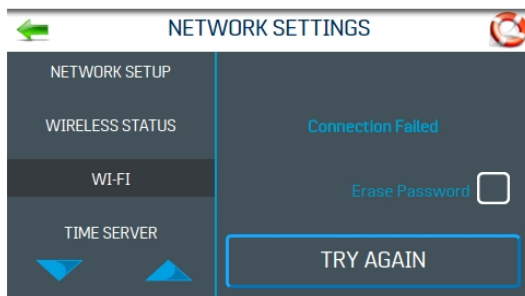

7. Tap **Disconnect** to end the connection.

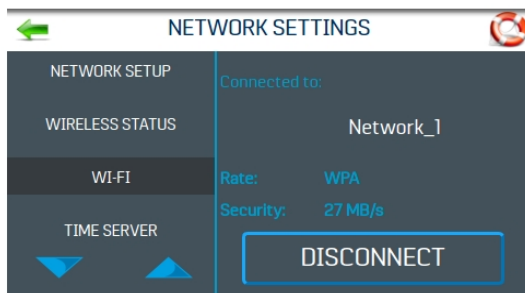

2 - Operating the Printer

In this section

| | |
|------------------------------------|----|
| Adjusting the Horizontal Alignment | 15 |
| Adjusting the Vertical Alignment | 15 |
| Adjusting the Print Job Properties | 16 |
| Checking Ink Status | 22 |
| Estimating Ink Usage | 23 |
| Selecting the Ink Type | 25 |
| Selecting the Language | 26 |

Adjusting the Horizontal Alignment

Horizontal alignment adjusts offset of individual printheads (side-to-side) offset to fine tune horizontal positioning of the printout.

To adjust the horizontal alignment:

1. Tap **Printer Setup** on the Main Menu, or press the **Quick Menu** button on the Control Panel.
2. Tap **Horizontal Alignment**.

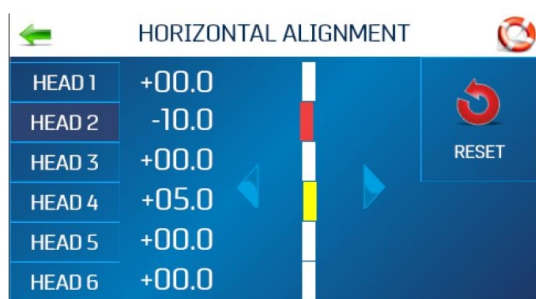

3. Select the desired printhead.
4. Tap the directional arrows to move the bar in the desired direction. You can align individual printheads up to ± 100.0 microns in 5.0 micron increments.
5. Tap **Reset** to reset the horizontal alignment to 00.0 (default).
6. Tap **Test Print** to print a test page using the current adjustments and print parameters to check printing quality and printhead alignment.

Adjusting the Vertical Alignment

Vertical alignment disables the top nozzles in individual printheads to remove any overlap to fine tune vertical positioning of the printout.

To adjust the vertical alignment:

1. Tap **Printer Setup** on the Main Menu, or press the **Quick Menu** button on the Control Panel.
2. Tap **Vertical Alignment**.



3. Select the desired printhead.
4. Tap the directional arrows to move the bar in the desired direction. You can adjust the individual printheads up to ± 1.0 microns in 0.1 micron increments.
5. Tap **Reset** to reset the vertical alignment to 0.0 (default).
6. Tap **Test Print** to print a test page using the current adjustments and print parameters to check printing quality and printhead alignment.

Adjusting the Print Job Properties

The printer driver describes to the printer how to print your job. It controls printer operation and allows you to send fixed and variable text and graphics to the printer. Use the properties to control and customize the printer's output.

To access these options, in your data management software, select **File > Print**

To print the job, click **Print**.

To use special features built into the printer driver, click **Preferences** or **Printer Properties** to open the Document Properties window.

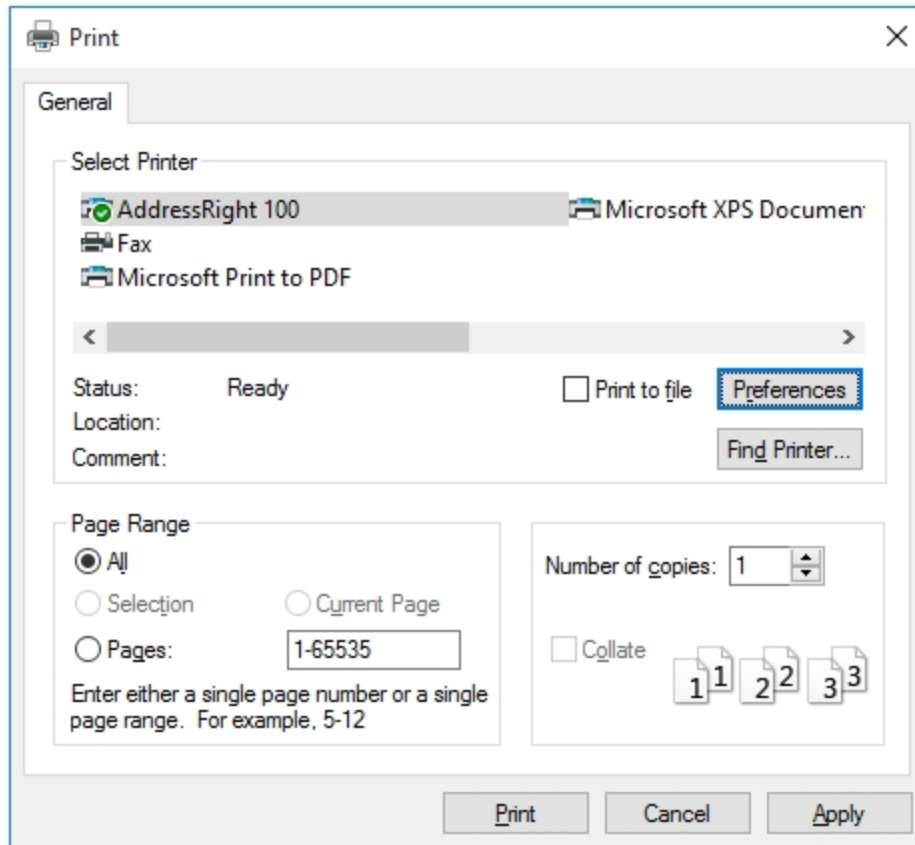

Layout

On the **Layout** tab, use the **Orientation** menu to select **Portrait** or **Landscape** orientation.

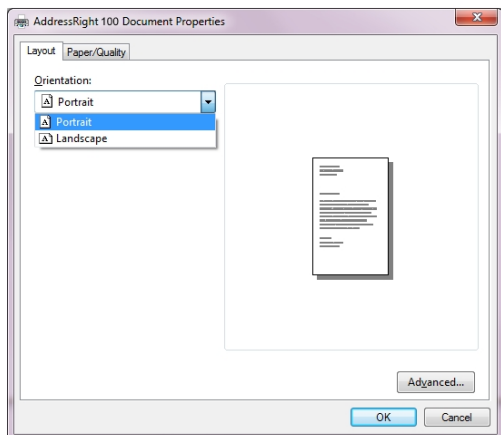

Paper/Quality

On the **Paper/Quality** tab, use the **Paper Source** menu to select your paper source automatically or to set **Normal Printing** or **Invert Printing**.

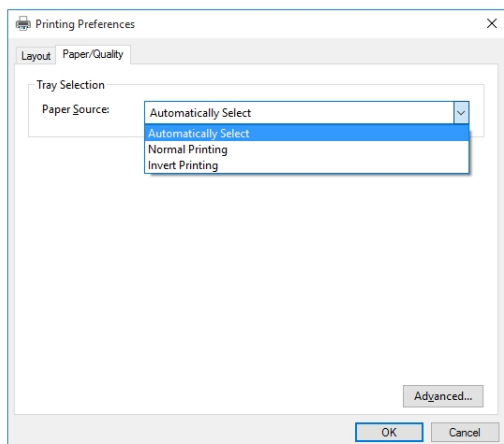

Inverting Printing

In normal operation, printing is read from the operator side of the printer. It is sometimes necessary to turn the printing direction 180 degrees from the normal direction. This occurs when due to layout or method of binding, media must be fed in reverse direction.

To invert printing (reverse the printing direction 180 degrees):

1. On the **Paper/Quality** tab, select **Invert Printing** from the **Paper Source** menu.

Advanced Options

On the **Paper/Quality** tab, click the **Advanced** button to open the Advanced Options window.

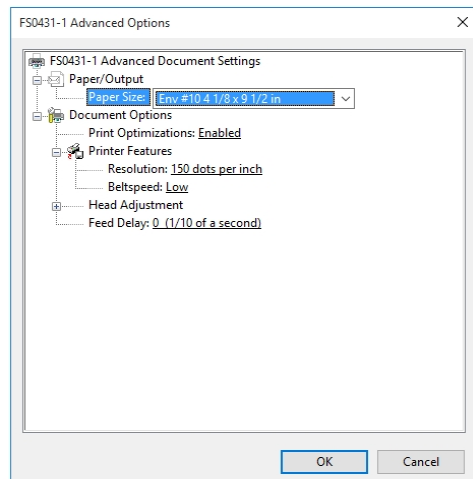

Paper/Output

From the **Paper Size** menu, select the size of media to be used.

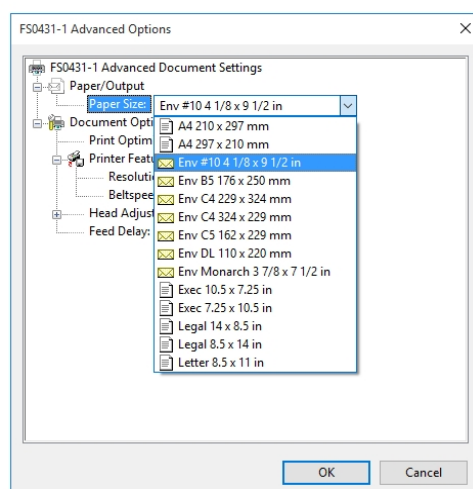

Printer Features

In **Printer Features** you can set the resolution of the printer, printer speed, and language the printer operates in, and add a delay to the feed to provide separation between pieces.

From the **Resolution** menu, set resolution of print quality. Changing resolution to a higher number (e.g. 200 DPI to 600 DPI) increases image quality. **Note:** Higher resolutions reduce print speed options.

| AddressRight 200 | |
|------------------|--------------------------------|
| Resolution | Speeds Available |
| 600 x 150 DPI | Low, Medium, Medium High, High |
| 600 x 200 DPI | Low, Medium and Medium High |
| 600 x 300 DPI | Low and Medium |
| 600 x 600 DPI | Low |

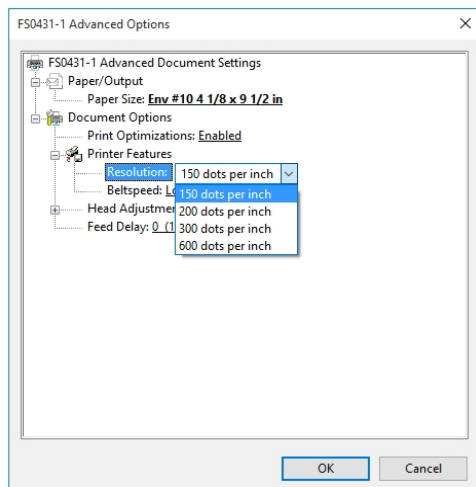

From the **Belt Speed** menu, set the print speed for the print job. The speeds available for a particular job are determined by the Resolution set for the job.

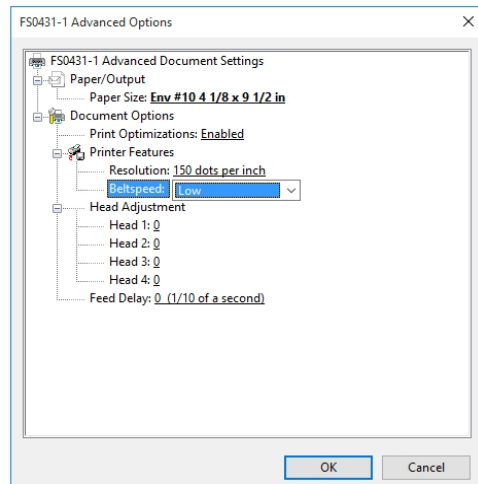

Head Adjustment

Use the Head Adjustment options to make slight (0.001") fine-tuning adjustments to the positions of the printheads in relation to each other. Adjustment is used to precisely align printheads when printing graphics or type that extends beyond width of one printhead.

Each head can be moved +/- 0.048" in 0.001" increments.

- To move the printhead toward the lead edge of the layout, use the **down** arrow.
- To move the printhead away from the lead edge of the layout, use the **up** arrow.

When the printer is turned off, any changes made here return to the original settings.

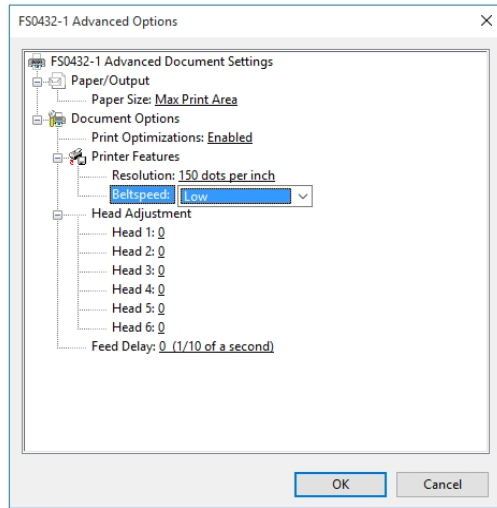

Feed Delay

The **Feed Delay** menu can be used to put more space between pieces as they are printed. This gives the first piece printed more time to dry before the next piece is printed.

Adjustments are made in 0.1-second increments.

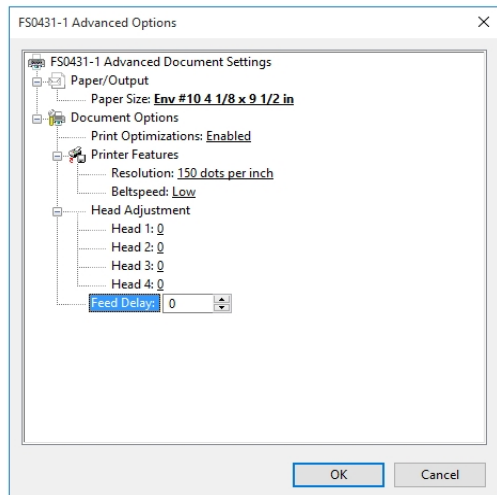

Checking Ink Status

Ink Status shows the percentage of ink remaining in each ink cartridge and the estimated number of prints remaining at a selected resolution. The estimation is based on the last page printed.

1. Tap **Tools** on the Main Menu or press the **Quick Menu** button on the Control Panel.
2. Tap **Ink Status**.
 - ----- Indicates no ink cartridge present or an unrecognized, unprogrammed ink cartridge.
 - ?????? Indicates an ink cartridge not programmed for this printer.
 - To select the resolution, tap the desired resolution on the right side of the screen.

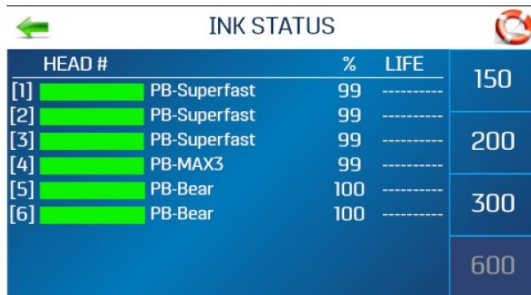

| HEAD # | | % | LIFE | |
|--------|--------------|-----|-------|-----|
| [1] | PB-Superfast | 99 | ----- | 150 |
| [2] | PB-Superfast | 99 | ----- | 200 |
| [3] | PB-Superfast | 99 | ----- | |
| [4] | PB-MAX3 | 99 | ----- | 300 |
| [5] | PB-Bear | 100 | ----- | |
| [6] | PB-Bear | 100 | ----- | 600 |

Improving the performance of a single ink cartridge (boosting the voltage)

To change the voltage of a single ink cartridge (vs. all cartridges of a certain type):

1. Tap the screen for the particular cartridge you wish to change.
2. Enter a new voltage value. From this point forward, the printer will remember that the voltage has been boosted for that particular cartridge, even if the cartridge is removed and reinstalled in this printer later.



Caution: Boosting the voltage above the maximum shown will damage the ink cartridge, cartridge holder and printer.

Estimating Ink Usage

The Ink Estimator estimates the cost of ink for a particular print job. The printer runs and simulates printing a preset number of pages.

Note: It is recommended that Purge First Piece be turned off from the Printer Preferences menu. This will use much less ink and increase the accuracy of the estimate.

1. Tap the **Ink Cartridge Cost** entry box and enter the cost of the ink cartridges.
2. Tap the **Number of Pages** entry box and enter the total number of pages for the entire print job planned.

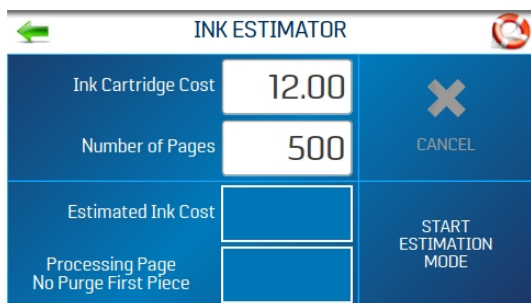

3. Tap **Start Estimation Mode** to start the Ink Estimator.



4. Send a sample job of up to 49 pages to the printer. Generally, the higher the number of pages sent, the more accurate the estimate.
5. **Estimated Ink Cost** displays the estimated ink cost for the entire planned print job.



Selecting the Ink Type

The Ink Type menu allows you to select the ink type, change the name of the ink cartridge, and increase voltage for a cartridge.



Note: Only authorized ink cartridges will be recognized by the printer. An empty cartridge holder or invalid or unprogrammed ink cartridge displays as “-----”. An ink cartridge that is programmed, but not recognized by this printer, displays as “????????”.

To select or change the ink type:

1. Tap **Printer Setup** on the Main Menu.
2. Tap **Ink Type**. The **Select Ink Type** screen opens, showing the recognized ink cartridge installed in each cartridge holder.
3. To select a particular ink cartridge, tap on it.
4. To change the name of the ink cartridge:
 - a. Tap the **Edit** (paper/pencil) icon next to the cartridge. The Edit Ink Type screen opens.



- b. Tap in the **Title** field and enter the desired name.

Boosting the voltage

If you have a complete set of ink cartridges of the same type that are performing poorly, you may be able to improve the performance of the group by boosting the voltage. If you need to affect the voltage of a single cartridge, see [Checking Ink Status on page 22](#).

Before taking this step, make sure that the cartridge has been properly cleaned. If print quality does not improve with cleaning, boost the voltage of all cartridges of the same type.

To increase the voltage for a type of cartridge:

1. Tap the **Edit** (paper/pencil) icon next to the cartridge. The Edit Ink Type screen opens.



2. Tap the **Boost** entry box to open the numeric keyboard to increase the voltage on a particular ink cartridge. **DO NOT increase the voltage more than the maximum listed on the touchscreen.**

Once entered, the printer memory will recall this information even if the cartridge is removed and reinstalled in this printer later.



Caution: Boosting the voltage above the maximum shown will damage the ink cartridge, cartridge holder and printer.

Selecting the Language

The Select Language menu sets the language that the printer touchscreen displays.

To change the language:

1. Tap **Printer Setup** on the Main Menu.
2. Tap **Language**.
3. Tap the desired language.



3 - Menus and Options

In this section

| | |
|-----------------------------|----|
| Quick Menu | 29 |
| Main Menu | 30 |
| Info Menu | 31 |
| Print Data Menu | 32 |
| Print Image Screen | 33 |
| Printer Preferences Menu | 35 |
| Printer Setup Menu | 37 |
| Tools Menu | 38 |
| Time Server (Date and Time) | 39 |
| Wireless Status | 40 |

Quick Menu

The **Quick Menu** button provides access to frequently-used printer functions. To open, press the **Quick Menu** button on the Control Panel. To close, press the **Quick Menu** button again.

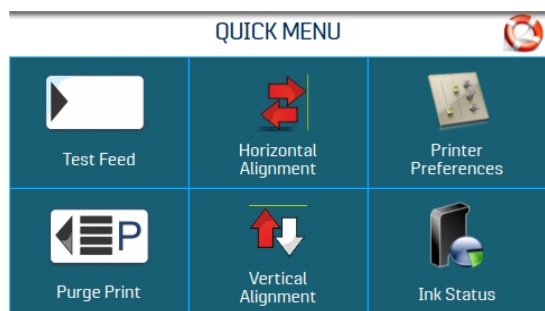

Test Feed/Reprint: The default is **Test Feed**. If no data is present, this button allows you to test feed blank sheets of media. If there is a printer jam or double feed, the **Test Feed** button becomes **Reprint**, which allows you to recover missed or misprinted pieces. Use the arrows to go back to the initial misprinted piece (or further back if desired) to start reprinting. Press **Print** to start printing.

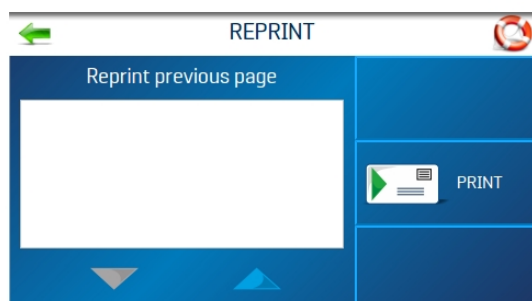

Purge Print: Prints an ink pattern at 600 dpi to clear all of the ink nozzles in all of the ink cartridges

Horizontal Alignment - Heads (1-6): Adjust offset of individual printheads (side-to-side) up to ± 100.0 microns in 5.0 micron increments.

Vertical Alignment - Heads (2-6): Disables the top nozzles in individual printheads to reduce nozzle overlap. Adjust up to ± 1.0 microns in 0.1 micron increments.

Printer Preferences: Sets printer features including Purge First Piece, Automatic Feed Start, Keep Nozzle Alive, Tray Break, Continuous Batch Counter, Feeder Delay, and Invert Printing.

Ink Status: Shows the percentage of ink remaining in each ink cartridge and the estimated number of prints remaining at the selected resolution.

Main Menu



The touchscreen Main Menu provides access to the following printer features:

Print Image: View current jobs and images and set up new jobs and images for printing

Printer Setup: Set printer parameters to adjust the printer to suit your needs

Tools: Access the Ink Cost Estimator, Ink Status, Diagnostic tests, Network settings, and Screen Calibration

Print Data: Displays information about the job that is currently printing

Test Print: Prints a test page using current settings to check printing quality and printhead alignment

Information: Displays information about the printer

Related topics

- [Print Image Screen on page 33](#)
- [Printer Setup Menu on page 37](#)
- [Tools Menu on page 38](#)
- [Print Data Menu on page 32](#)
- [Info Menu on the next page](#)

Info Menu

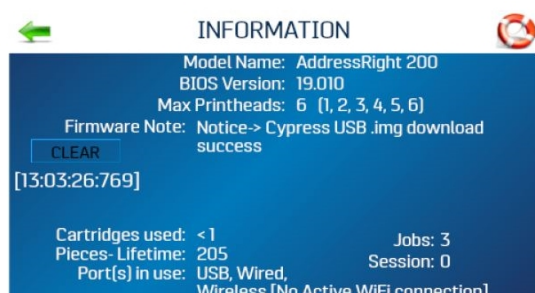

The Info menu displays the following information about the printer:

Model Name: Printer model

BIOS version: Current version of firmware installed

Max. Printheads: Number of printheads in this printer model

- x: printhead installed
- -: printhead missing or problem.

Firmware Notice: Firmware status

Cartridges used: Total number of ink cartridges emptied by the printer

Pieces-Lifetime: Total number of prints that have passed through the printer (cannot be reset)

Jobs: Total number of jobs run during the printer lifetime

Session: Total number of jobs run on the printer since it was last turned off

Port(s) in Use: Displays which printer ports are being used

Print Data Menu

The Print Data menu displays information about the job that is currently printing.

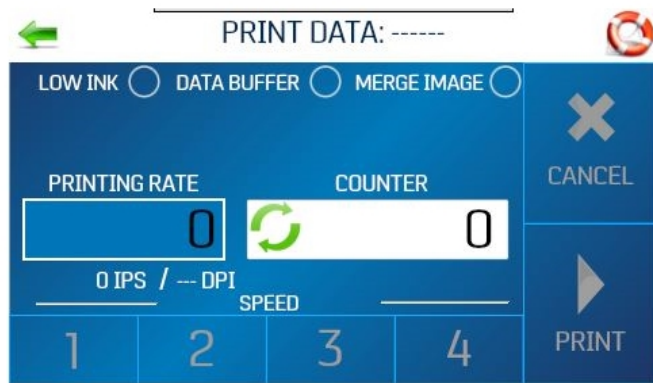

Low Ink: Indicator turns yellow when one or more cartridges are low.

Data Buffer: Indicator turns green when data is present in the buffer.

Merge Image: Indicator turns green when an image is loaded.

Printing Rate: Shows how many pieces are printing per hour, the **Speed** (ips), and **Print Quality** (dpi) set for the print job

Counter: Shows the number of pieces run for a particular job

Reset Button (inside Counter box): Resets the **Counter** to **0**.

Speed: Shows print speeds (**1-4**) available for a print job

Cancel: Cancels a running or paused print job

Pause/Print: Prints a job, pauses a running job, or restarts a paused job. You can also perform these functions using the Feeder ON/OFF button on the Control Panel.

Print Image Screen

Use the Print Image screen to view current jobs and images and set up new jobs and images for printing. To access the Print Image screen, tap **Print Image** on the Main Menu.

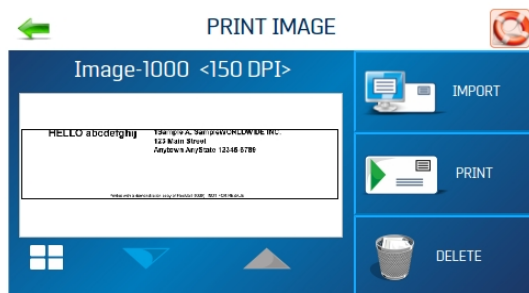
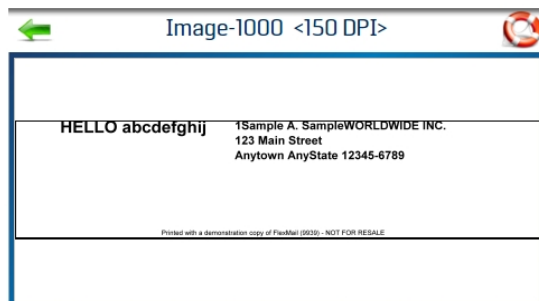

Image-XXXX: The left side of the screen displays the current jobs/images in the image library with their printing parameters. Use the arrows to scroll through and select images from the printer image library. Tap the white button in the lower left to display up to four current images simultaneously.

For a full screen preview, tap the image. The image will fill the touchscreen for easier viewing. Tap the image again to return to the normal screen view.



Import: Select **Import** to prepare the printer to accept a single mail piece template that can be used to merge with a future print job. The image must be saved at 600 DPI resolution.



Print: Opens the Print Image Setup screen (details below)

Delete: Permanently deletes the job or image from the printer image library

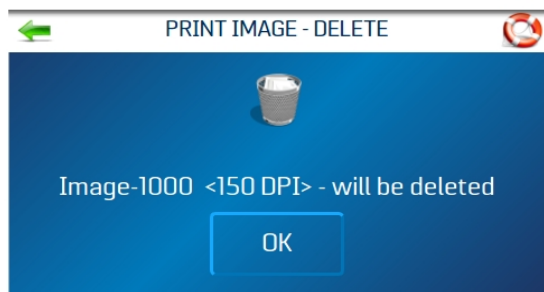

Print Image Setup

Tap **Print** on the Print Image screen to open the Print Image Setup screen. Once a job is loaded, the image name and DPI at which it was sent are displayed at the top of the screen.



Counter: Enter the number of copies to be printed. The printer counts down from the number set on the screen. The **Reset** button inside the counter box resets the counter to 1.

Print Quality: Shows the **Speed** in inches per second (ips) and **Print Quality** (dpi) set for the print job. Print Quality is determined by the **Print Resolution** set in the image or print job.

Speed: Shows the speeds available (**1=Slowest; 4=Fastest**) for a particular job. Speeds available are determined by the **Print Resolution/Print Quality** set in the image or print job.

Merge: Merge the image with a database and opens the Print Data screen to monitor the status of the printing job. The new job must match the page size and layout of the merged image. To merge with a database, the image must be saved at 600 dpi.

Print: Press **Print** to start printing the job.

Printer Preferences Menu

To access the Printer Preferences menu, tap **Printer Setup** on the touchscreen Main Menu, or press the **Quick Menu** button on the Control Panel.



Purge First Piece: Turning this feature on causes the printer to send one purge pattern on the first piece. After the purge is completed, the next piece will be the first record of your database. Once this feature is selected, it remains on, even if the printer is turned off.

Automatic Feed Start: Turning the feature on causes the printer to start feeding once the job is sent. The printer will come online and start feeding and printing automatically. Turn this feature off to use the Print button on the touchscreen (or **Feeder ON/OFF** on the Control Panel) to start printing. Turning the printer on or off does not affect your selection.

Keep Nozzles Alive: Prevents unused printhead nozzles from becoming dehydrated during a printing job:

- Checked: Nozzles spit to stay hydrated
- Unchecked: Nozzles do not spit
- Frequency menu: Sets the spitting frequency: **1x**, **2x**, **4x** (default), or **8x**. The **600 dpi Test** spits through all the nozzles at once. This may be used to find a problem with the printhead nozzles, or to clear the printhead after sitting idle for a long period of time.

Tray Break: The printer will search for break marks (spaces between media pieces) and respond according to the settings. To pause or set a gap within a print job, select the edit (paper/pencil) icon, then set the desired option:

- Select **Feeder Stop** and set the timer to pause/stop the feeder at predesignated breaks during a print run. Enter time in seconds (1-60). On sensing the break mark, the feeder stops for the specified number of seconds.
- **Conveyor Gap** is used when the printer is set up in line with other mailing equipment (conveyors, tabbers, etc.) When this feature is activated, the printer responds to the break mark by sending a signal to the conveyor to speed up momentarily. This creates an obvious gap between the end of one set of pieces and beginning of the next. Select and set the gap on a conveyor between predesignated breaks during a print run. Enter the distance between the media sensor and the conveyor. The printer sends a delayed signal to an external device and continues to feed.

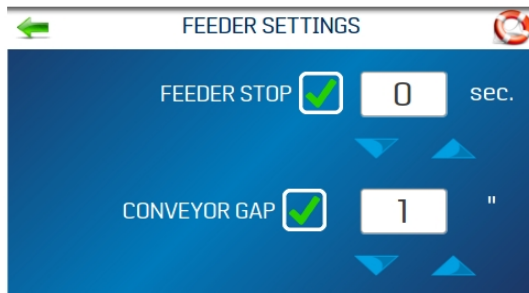

Continuous Batch Counter:

- Unchecked: Batch Counter resets before each job
- Checked: Batch Counter does not reset before each job

Feeder Delay: Used to lengthen the time between pieces being fed. Used for jobs that require longer drying time before they are stacked.

- Unchecked: No Feeder Delay
- Checked: Feeder Delay is activated. In the box, set the amount time the feeder will pause in tenths of a second. This applies only to internal print jobs on the printer (for example, Test Print, Purge Print, and images stored in the printer image library.) Jobs sent to the printer with this parameter already set will override this feature.

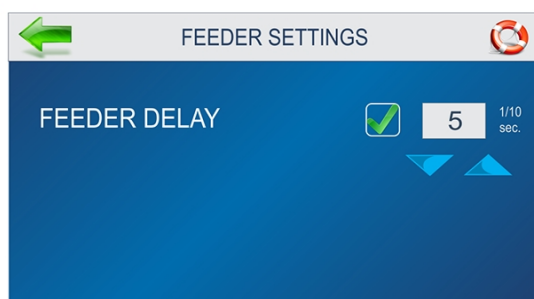

Invert Printing: In normal operation, the printing is read from the operator side of the printer. It is sometimes necessary to turn the printing direction 180 degrees from the normal direction, when, due to the layout or binding method, the media must be fed in the reverse direction.

- Unchecked: Prints the job normally
- Checked: Prints the job inverted (turned 180 degrees). This feature applies only to internal print jobs (for example, Test Print, Purge Print, and images stored in the printer image library).

Printer Setup Menu

The Printer Setup screen allows you to set the printer parameters to adjust the printer to suit your needs. To access the Printer Setup screen, tap **Printer Setup** on the Main Menu.

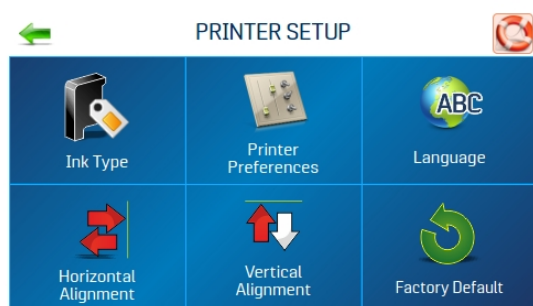

Ink Type: Opens the Ink Type menu to display the ink types loaded in the ink cartridge holders. Only authorized ink cartridges will display. Select an ink type to edit the options.

Printer Preferences: Opens the Printer Preferences menu printer to access Purge First Piece, Automatic Feed Start, Keep Nozzles Alive, Tray Break (Feeder Stop and Conveyor Gap), Continuous Batch Counter, Feeder Delay, and Invert Printing

Language: Selects the language in which the printer touchscreen will display

Horizontal Alignment: Fine-tunes the spacing of the printheads (1-6) in relation to each other horizontally (side-to-side)

Vertical Alignment: Fine-tunes the spacing of the printheads (2-6) in relation to each other vertically (front-to-rear)

Factory Default: Returns the Printer Setup to the factory default settings

Related topics

- [Selecting the Ink Type on page 25](#)
- [Printer Preferences Menu on page 35](#)
- [Selecting the Language on page 26](#)
- [Adjusting the Horizontal Alignment on page 15](#)
- [Adjusting the Vertical Alignment on page 15](#)
- [Restoring Factory Defaults on page 51](#)

Tools Menu

Tap **Tools** on the Main Menu to open the Tools screen.

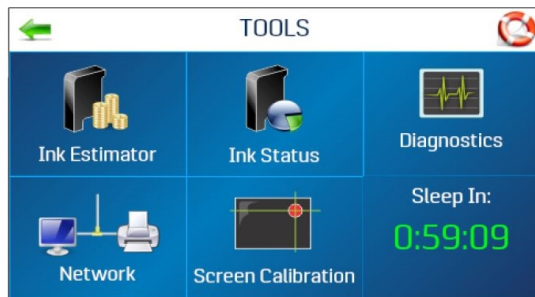

Ink Estimator: Estimates the cost of ink for a particular print job. The printer simulates printing up to 49 pages of the job to be printed and determines the estimated ink cost for the entire job.

Ink Status: Displays the percentage of ink left in the ink cartridges and the estimated number of prints remaining for each cartridge at a selected resolution, based on the last page printed

Diagnostics: Runs diagnostic tests on key printer systems and components

Network: Sets up wired or wireless (Wi-Fi) access to a network. **Wireless Status** displays network information about the Wi-Fi connection. **Time Server** displays information about the source used for date and time when the printer is connected to an internet-connected network.

Screen Calibration: Sets the touch pressure (sensitivity) needed to activate the touchscreen

Related topics

- [Estimating Ink Usage on page 23](#)
- [Checking Ink Status on page 22](#)
- [Running Diagnostics on page 51](#)
- [Entering the Network Settings on page 12](#)
- [Calibrating the Touchscreen on page 42](#)

Time Server (Date and Time)

The Time Server option on the Network Settings screen displays the IP address and network name of the Time Server being used.

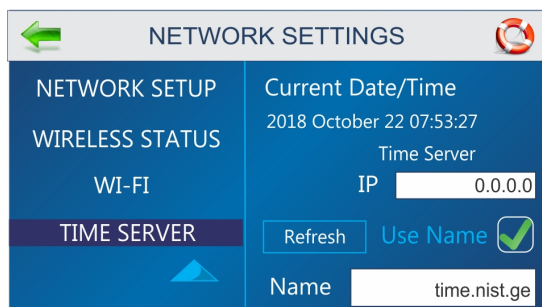

Wireless Status

The Wireless Status option on the Network Settings screen displays information about the wireless network connection.

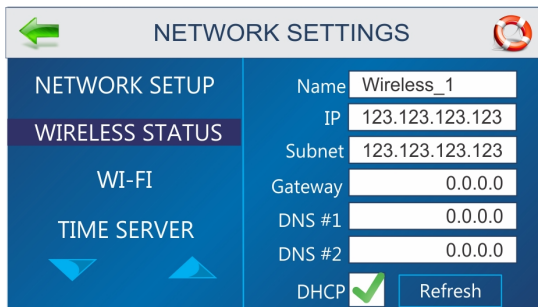

4 - Maintenance

In this section

| | |
|--|----|
| Calibrating the Touchscreen | 42 |
| Cleaning the Printer | 42 |
| Cleaning the Printhead | 44 |
| Inkjet Cartridges | 45 |
| Printer Jams | 47 |
| Purging the Nozzles | 47 |
| Replacing the Inkjet Cartridges | 48 |
| Replacing the Metering Segments (Sheet Separators) | 49 |
| Restoring Factory Defaults | 51 |
| Running Diagnostics | 51 |

Calibrating the Touchscreen

Calibrate the touchscreen to adjust the touch pressure (sensitivity) needed to activate functions on the touchscreen.

- Lower percentage = less pressure, more sensitive
- Higher percentage = more pressure, less sensitive.

To calibrate the screen:

1. From the Main Menu, tap **Tools**.
2. Tap **Screen Calibration**.
3. Follow the instructions on the screen to perform the calibration. **Time Remaining** counts down the 15 seconds given to complete each step. A screen message informs you if the calibration succeeded or failed.

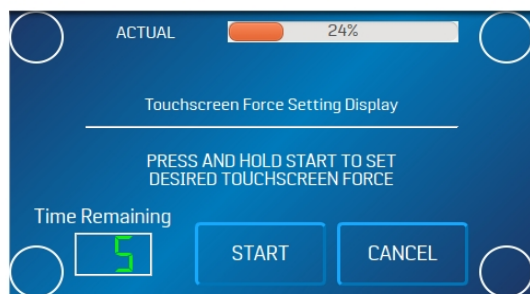

Cleaning the Printer



Warning! Printer is a precision machine that should be cleaned regularly to insure many years of service. Before performing any maintenance disconnect printer from its power source!

The printer must be cleaned regularly of accumulated paper dust and ink. Depending on the types of media run, paper dust may accumulate within the printer and on the transport. Before cleaning the printer, unplug it from the power receptacle.

External areas may be cleaned with any non-abrasive standard household cleaner that does not contain plastic harming solvents.



Caution: Never spray or pour cleaners directly on or into printer. Excess liquid could harm electronic parts. Always dampen a rag with the cleaner and apply it to parts to be cleaned.

Feed Rollers and Forwarding Rollers

Feed and forwarding rollers can become glazed with paper lint and ink from media. Clean regularly with a mild abrasive household cleaner on a damp cloth. Avoid using solvents on rubber rollers.

Cleaning the Media Sensor

Periodically check the media sensor, located under the media hold-down wheel assembly, for dust and debris.

1. Use the media thickness knob to raise the printhead carriage assembly to its highest setting.
2. Use canned or compressed air into the media sensor port [A] and under the media sensor reflector [B] to remove dust and debris.

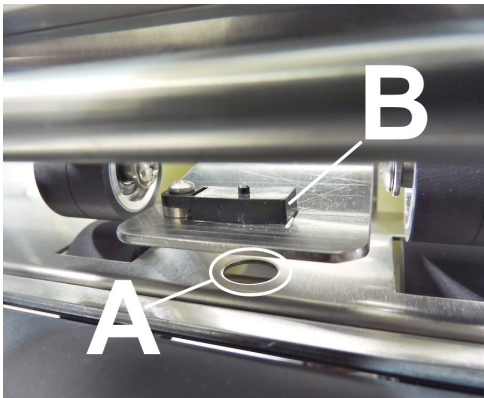

Note: If necessary, wipe the reflector surface (under the mounting plate) with a clean, lint-free cloth.

Cleaning the Touchscreen

Carefully clean the touchscreen by wiping with a lint-free cloth and a non-abrasive cleaner made for touchscreens on computers and cell phones. **DO NOT spray cleaner directly on screen. Spray on cloth, then clean screen.**

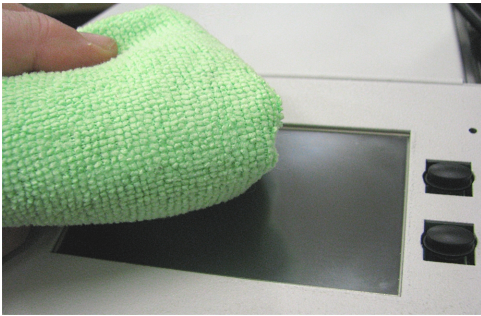

Cleaning the Printhead

Maintain good print quality by keeping printheads clean. During printing, ink spray, paper fibers, and dust build up on the printheads. This buildup eventually degrades print quality. If you notice problems with print quality, or to prevent a buildup from occurring, wipe the printhead with a wet fiberless, lint-free cloth.

| Cloth should be: | Cloth should not be: |
|---|-----------------------------------|
| Soft | Abrasive |
| Fiberless, lint-free | Made of small fibers |
| Moistened with water (Distilled is best but tap water works) | Dry or contain chemical additives |

Wipe slowly across the long axis with the printhead facing down (as shown). **DO NOT** apply excessive force, as this could scratch the nozzle area.



Inkjet Cartridges

Replace printer ink cartridges when out of ink, when print quality is poor, or when purging and cleaning have not helped image quality. Approximate life of the ink cartridges based on three lines of 20 characters at 10-point size per address:

| | |
|---------------|-------------------|
| 600 x 600 DPI | 50,000 addresses |
| 300 x 600 DPI | 100,000 addresses |
| 200 x 600 DPI | 150,000 addresses |
| 150 x 600 DPI | 200,000 addresses |

Note: These figures can vary depending on font selected.



Caution: Never shake, drop or hit cartridges against the palm of your hand or any other hard surface. Shaking the print cartridge does not mix ink and hitting cartridges against a hard surface does not clear nozzles. These actions hurt print quality because they allow bubbles to form near the ink firing chambers. These bubbles prevent the nozzles from firing, causing white streaks in print image.

Ink cartridge levels

The level of ink remaining in a cartridge is an estimate only. When a cartridge is inserted into a printer for the first time, the printer assumes that it is 100% full. As the ink is used, the printer estimates the percentage of ink remaining in the cartridge. If a used cartridge is placed into a different printer for the first time, it will be shown as 100% full. The ink level should be used as a guide only and not an exact level of remaining ink. Heat and humidity can also affect the accuracy of ink level estimates.

Note: If the SD card is removed by a qualified technician, all history of ink cartridge levels and voltage boost values will be lost.

Storage

Short-term Storage (less than 2 days or less than 1 day in a hot and dry environment)

- Leave cartridge in printer for short periods of time, 1 day or less.
- Next time that the printer is used, printhead may have to be cleaned and purged.

Long-term Storage (more than 2 days or more than 1 day in a hot and dry environment)

- Place the plastic nozzle cover on the cartridge. Place cartridges in a sealable plastic container with a damp sponge or towel to maintain humidity and prevent printhead from drying out.
- When cartridges are ready to be used again, printhead will need to be cleaned.

Disposal

Cartridges may be disposed of in a normal manner.

In case of an ink spill, use soap and water to clean up any problem areas.

Abrasive soap usually removes ink off of hands.



Caution: Ink in cartridge may be harmful if swallowed. Keep new and used cartridges out of reach of children. Discard empty cartridges immediately.

Printer Jams

If a jam occurs, **stop the printer**. Use the main power switch if necessary.

To recover missed addresses, press the **Quick Menu** button on the Control Panel, then tap **Reprint**. Up to 10 missed addresses can be recovered at the printer Control Panel.

Some possible reasons for jamming are:

- Feeding more than one piece of media.
- Damaged media, such as dog-eared (turned down corners).
- Media that is not stiff enough may not be usable. Media that meets Postal stiffness requirements for automated feeding is acceptable in the printer.
- Envelopes caught under flap of another envelope or stuck to one another (double-feeding) may cause jamming.

Removing Jammed Media

It may be necessary to move one or more printheads to gain access to jammed media. Take care in removing jammed media to prevent damage to printheads. All pieces of jammed media must be removed from feed path.

Purging the Nozzles

If the printhead sits inactive for a period of time, ink may dry in the nozzles. Printing may not remove these ink plugs from the nozzles. White streaks appear in printed text or graphic. To improve print quality, these ink plugs need to be forced out or purged. A purge print routine is built into the printer to clear the nozzles.

To purge the nozzles:

1. Wipe the printhead with a wet cloth.
2. With media loaded in the feeder, press the **Quick Menu** button on the Control Panel, then tap **Purge Print**.

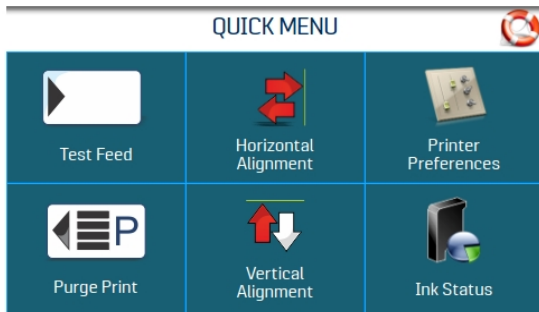

3. Tap **Print** to activate the purge. Purge prints an ink pattern at 600 DPI to clear all of the nozzles in all of the ink cartridges. Repeat if necessary.
4. Wipe the printhead again with a moist cloth.

Replacing the Inkjet Cartridges

1. Open the latch lever to remove the used cartridge from the cartridge holder. Pull the cartridge up and out of the holder.

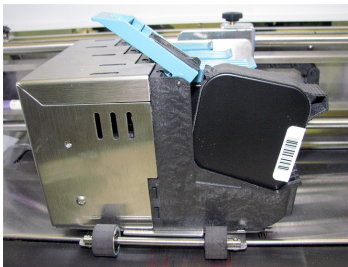

2. Remove the new cartridge from packaging. Take care not to touch the copper contacts, metal plate, or gold printhead. Remove the protective tape from the printhead.
3. With the cartridge's printhead pointing down, slide the cartridge into the holder. Push down and toward the contacts in the holder.

4. Make sure that the cartridge is seated in the holder. Close the latch lever to secure the cartridge. **DO NOT** force the latch lever into place.

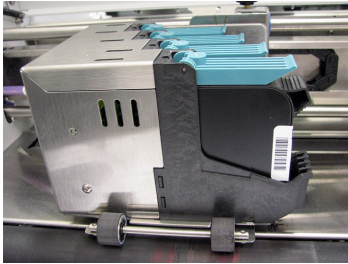

5. Repeat for remaining cartridges.



Caution: Never shake, drop or hit cartridges against the palm of your hand or any other hard surface. Shaking the print cartridge does not mix ink and hitting cartridges against a hard surface does not clear the nozzles. These actions hurt print quality because they allow bubbles to form near the ink firing chambers. These bubbles prevent the nozzles from firing, causing white streaks in print image.

Replacing the Metering Segments (Sheet Separators)

Metering Segments (sheet separators) ensure separation of pieces as they are fed. They wear and must be replaced periodically. If you experience double sheet feeding and cannot adjust the separators to prevent it, replace them.

You can order sheet separators at pitneybowes.com, supply item number 90-103-09s.

Watch this video or follow the steps below to learn how to replace the metering segments (sheet separators):

Restoring Factory Defaults

The Factory Default menu restores all operator-initiated adjustments and settings to the factory settings.

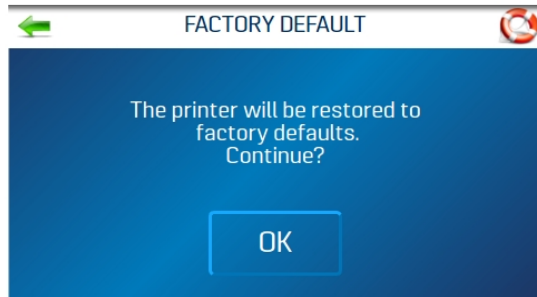

Running Diagnostics

Diagnostics runs tests on the printer components and systems listed on the screen at variable speed.

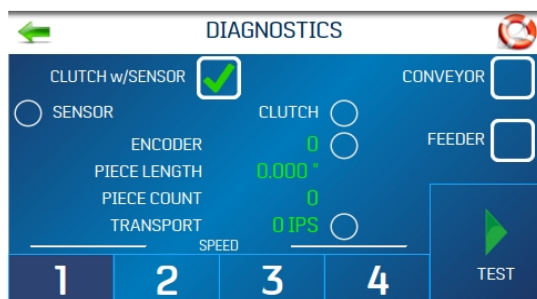

To run a diagnostic test:

1. Remove media from the printer.
2. Tap **Test** to start the diagnostic cycle. Tap again to stop.
3. While **Test** is activated, run one piece of media through the printer to test the sensor function. The test cycles through each component automatically. Green lights indicate that the component is functioning properly.

4. After running one piece, verify that the piece length was measured accurately.
 - If the piece fed through, but no piece length was displayed and the sensor condition still shows red; stop this test, turn off the printer, and clean the media sensor.
 - If the piece measured longer than the actual piece length; the piece is probably slipping or hesitating as it feeds. In this case, check or adjust the sheet separators and check and adjust the media thickness setting.
5. Check or uncheck the **Clutch w/Sensor** box as needed:
 - **Unchecked:** Tests clutch function (on/off) using an automated routine.
 - **Checked:** With media loaded, tests clutch and media sensor function.
6. Check or uncheck the **Conveyor** box to turn the conveyor relay on and off. (Listen for the relay clicking.)
7. Check or uncheck the **Feeder** box to turn the feeder relay on and off. (Listen for the relay clicking.)

5 - Specifications

In this section

Printer Specifications

54

Printer Specifications

| | |
|--|--|
| PRINT TECHNOLOGY | 6-Head Inkjet |
| ADDRESS SPEED | Up to 30,000/hour (#10 Envelopes) |
| PRINT QUALITY/SPEED (Dots Per Inch) | 1-High Quality 600 x 600 DPI (25 in./sec.; 125 ft./min.; 38 m/min.) 2-Standard Quality 600 x 300 DPI (50 in./sec.; 250 ft./min.; 76 m/min.) 3-Letter Quality 600 x 200 DPI (75 in./sec.; 375 ft./min.; 114 m/min.) 4-Draft Quality 600 x 150 DPI (100 in./sec.; 500 ft./min.; 152 m/min.) |
| IMAGE AREA | 3" x 15" (76.2 mm x 381 mm) |
| PRINT ORIENTATION | Right-to-Left |
| FONTS | All TrueType fonts available on PC |
| PRINTS | Prints graphics, logos, and barcodes |
| MATERIAL SIZE (Minimum to Maximum) | Length: 5" to 15" (127 mm x 381 mm) Width: 2.75" to 10" (69.9 mm x 254 mm) |
| MATERIAL THICKNESS | Minimum: 0.008" (0.2 mm) Maximum: 0.375" (9 mm) |
| FEEDER CAPACITY | Up to 750 #10 envelopes |
| PROCESSOR | 600 Mhz Dual-core ARM Cortex-A9 MP Core |
| MEMORY | 1 GB of DDR3-1600Mhz SDRAM 8 GB (default) microSD. Not externally accessible |
| PRINT COLORS | Proprietary water-based inks in inkjet cartridges |
| INK | Water-based, may require drying assistance for coated stock |
| INK MONITOR | Visible on Touchscreen Display |
| SOFTWARE | Windows™ compatible Printer Drivers for Windows™ operating systems |
| DIAGNOSTICS | Resident in firmware |

Specifications

| | |
|-----------------|--|
| FIRMWARE UPDATE | Flash PROM update |
| PC INTERFACE | Ethernet Port (10/100/1000Mhz) USB 3.1 Port (also supports USB 2.0) Wireless with external wireless to USB adapter |
| COUNTERS | Lifetime Piece Counter, Session Counter, Jobs Counter |
| DIMENSIONS | 21.25" H x 28.75" L x 23" W (54 cm H x 73 cm L x 58.4 cm W) |
| WEIGHT | 80 lbs. (36.3 kg.) |
| ELECTRICAL | Switchable: 115VAC or 240VAC, 50/60 Hz |
| OPTIONS | Conveyor and Drop Tray |

All Specifications Subject To Change Without Notice

6 - Contacting Pitney Bowes

In this section

Contacting Pitney Bowes

57

Contacting Pitney Bowes

For service and support:

Visit our website at:

pitneybowes.com

For parts and supplies:

Visit our website at:

pitneybowes.com

7 - Safety

In this section

| | |
|-----------------------|----|
| Product Documentation | 59 |
| Safety Information | 59 |

Product Documentation

Visit pitneybowes.com for the latest product documentation. For Operator Guides, search “AddressRight Printers”.

Safety Information

This document contains safety information related to the AddressRight® 100, 200, and 300 printers and AddressRight® 300 Feeder.

To avoid personal injury or damage to the equipment, familiarize yourself with proper procedures and methods before you install, operate or repair the system.

Follow these safety precautions whenever you use your address printer:

- Use this equipment for its intended purpose.
- Place the system close to an easily accessible wall outlet.
- Be certain the area in front of the wall receptacle into which the machine is plugged is free from obstruction.
- Place the system in an accessible location to allow for proper venting of the equipment and to facilitate servicing.
- Use AC power cord included with device.
- Plug the AC power cord directly into a properly grounded wall outlet located near the equipment and easily accessible. Failure to properly ground the machine can result in severe personal injury and/or fire.
- The AC power cord is the primary means to disconnect this device from the AC power supply.
- DO NOT use an adapter plug on the line cord or wall outlet.
- DO NOT use a wall outlet controlled by a wall switch or one that is shared with other equipment.
- DO NOT remove the ground pin from the line cord.
- Always unplug the printer and discharge static electricity before using aerosol dusters.
- Improper storage and use of aerosol dusters or flammable aerosol dusters can cause an explosive-like condition that could result in personal injury and/or property damage.
- Never use aerosol dusters labeled flammable and always read instructions and safety precautions on the duster container label.
- DO NOT route the power cord over sharp edges or trap it between pieces of furniture. Make sure there is no strain on the cord.
- Use only approved supplies.

- Operation of this equipment without periodic maintenance will inhibit optimum operating performance and could cause the equipment to malfunction.
- If the unit becomes damaged, unplug it from the wall.
- Keep fingers, long hair, jewelry and loose clothing away from moving parts at all times.
- Always follow specific occupational safety and health standards for your workplace.
- Remove jammed material gently and carefully.
- To reduce the risk of fire or electrical shock, DO NOT attempt to remove covers or disassemble the control panel or its base. The cabinet encloses hazardous parts.
- Avoid touching moving parts or materials while the machine is in use. Before clearing a jam, be sure machine mechanisms come to a complete stop.
- Before operating the AddressRight™ Printer/Feeder, make sure that it has been properly prepared and that any other personnel in the area are standing clear of the machine.
- Immediately report to service any damaged or non-functioning components that renders the unit unsafe.
- DO NOT remove covers. Covers enclose hazardous parts that should only be accessed by properly trained service personnel.
- DO NOT run printer with top cover open.
- Running the printer with top cover open increases the risk of entanglement with moving parts.
- To prevent overheating, do not cover vent openings.
- DO NOT place lighted candles, cigarettes, cigars, etc., on the system.
- Contact Your System Supplier for:
 - Supplies
 - Material Safety Data Sheets
 - If you should damage the unit
 - Required maintenance service schedule

Servicing

This product is serviceable. For service inquiries in the USA, please visit pitneybowes.com/support.

This Equipment contains a Radio Frequency Transmitter operating in the 2.4 or 5 GHZ ISM band.



Caution: In case of ink spill, leaking ink or excessive ink accumulation, immediately disconnect the power cord from the wall plug and contact Pitney Bowes. In the USA, please visit pitneybowes.com/support.



3001 Summer Street
Stamford, Connecticut 06926
www.pitneybowes.com

For Service or Supplies

SV63324 Rev. C
©2020 Pitney Bowes Inc.
All Rights Reserved