



Specifications/Technical data (subject to change without prior notice):

	WW-200 DUO 2 in 1 wire binding
Max. punching capacity, paper	20sheets(80gsm/20lbs)
Max. punching capacity, plastic foils	2sheets(0.18mm/7mil)
Punching margin control(for 2:1 only)	2mm - 6mm(3/32" - 1/4")
Binding capacity	Max. wire size: 32mm(1-1/4"), for 280 sheets
Max. width of paper	A4, Letter and extra large size
Punching slots	A4 size: 34 for 3:1, 23 for 2:1 Letter size: 32 for 3:1, 21 for 2:1
Adjustable paper stop	Yes
Net weight	14.2kgs(31.24lbs)
Dimensions(W x D x H)	360x440x190mm(14" x 17" x 7.5")

Binding guide – 2:1

Wire(mm/inch)	Sheets	Margin
6mm 1/4"	25	2
8mm 5/16"	45	2
10mm 3/8"	65	2
11mm 7/16"	95	2
12mm 1/2"	125	4
14mm 9/16"	145	4
16mm 5/8"	155	4
19mm 3/4"	195	4
22mm 7/8"	220	6
25mm 1"	245	6
28mm 1-1/8"	270	6
32mm 1-1/4"	320	6

Binding guide – 3:1

Wire(mm/inch)	Sheets
6mm 1/4"	25
8mm 5/16"	45
10mm 3/8"	65
11mm 7/16"	80
12mm 1/2"	95
14mm 9/16"	125

2-in-1 Binding Machine

WW-200 DUO

Wire binding pitch 3:1 + 2:1
Reliure Anneaux Métal Pas 3:1 + 2:1
Encuadernación de wire paso 3:1 + 2:1
Drahtbindung Teilung 3:1 + 2:1

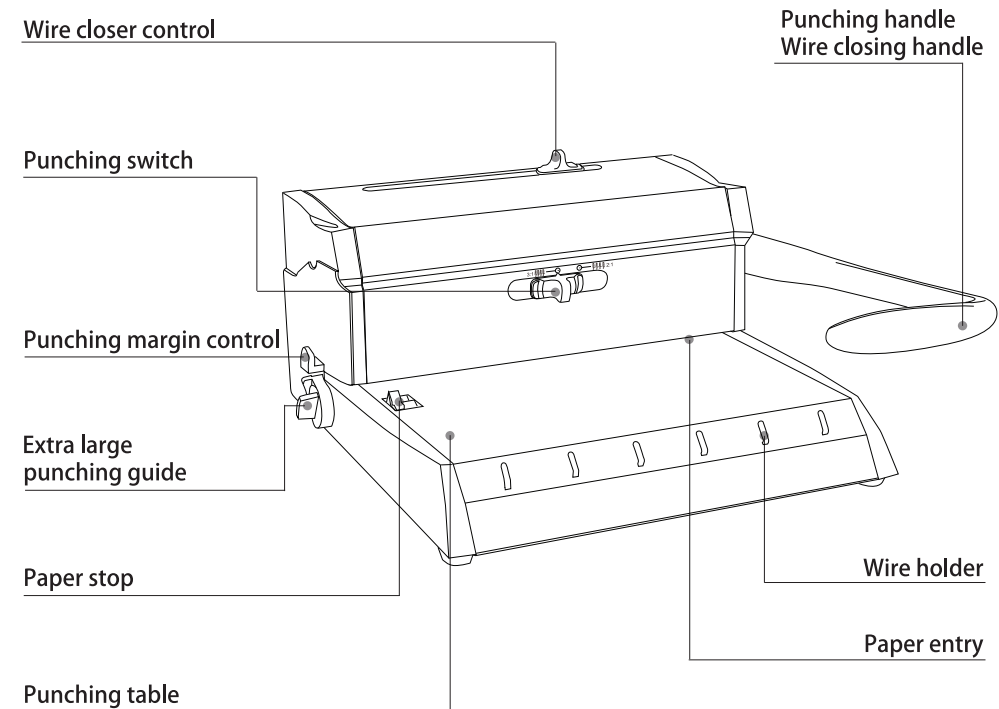

Intimus International GmbH
Bergheimer Straße 6 - 12
88677 Markdorf / Germany

Tel.: ++49 (0)7544 / 60-0
Fax.: ++49 (0)7544 / 60-248
E-mail: sales.de@intimus.com
www.intimus.com

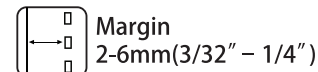
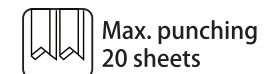
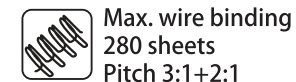

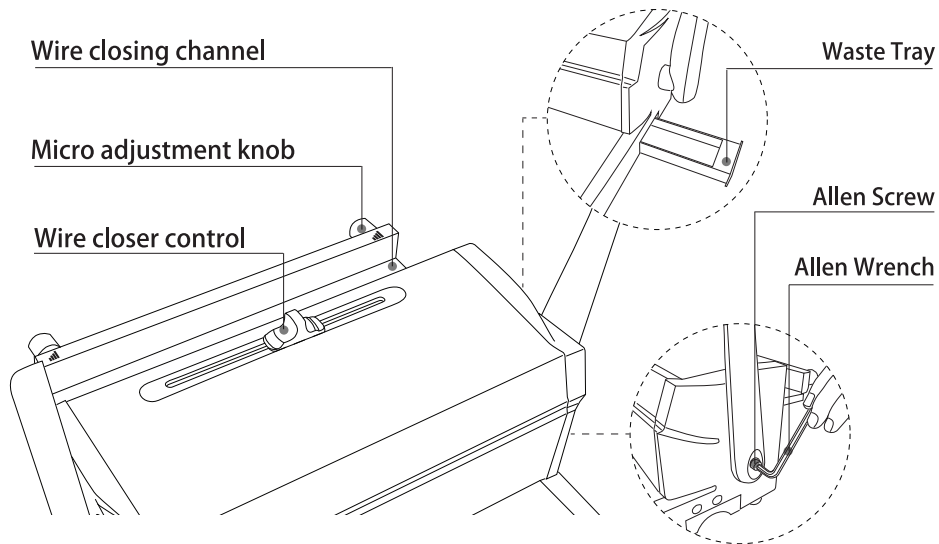

Assemble the Punching handle vertically with the provided Allen wrench and Allen screw. Set the Punching switch with the Punching handle at full upright position. Insert paper for punching only after you finish setting up the Punching switch.

Punching

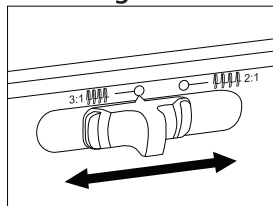

(Fig.1) Get ready: Set the **Punching Switch** for required punching format.

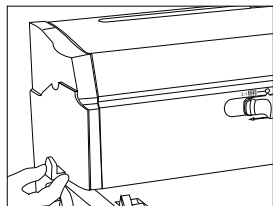

(Fig.2) Get ready: Set the **Punching margin control** at the desired position.

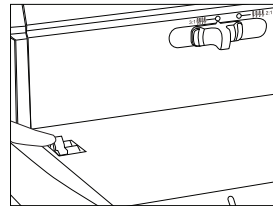

(Fig.3) Get ready: Set the **Paper stop** at the desired position.

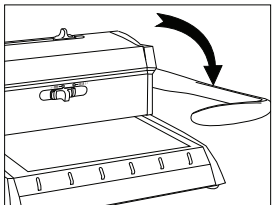

(Fig.4) Push paper(max. 20sheets) into the **Paper entry**. Pull the **Punching handle** all the way down until it stops to punch completely through.

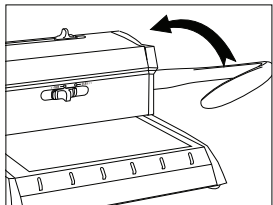

(Fig.5) Push back the **Punching handle** to its original upright position. Remove punched sheets.

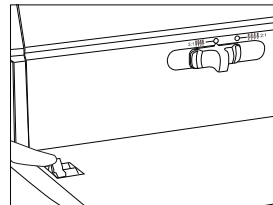

(Fig.6) **Extra large punching guide:** Set the **Paper stop** flush along with the **Punching table**.

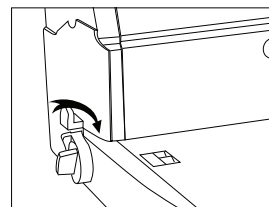

(Fig.7) **Extra large punching guide:** Rotate the **Extra large punching guide** and expose the desired registration pin for punching.

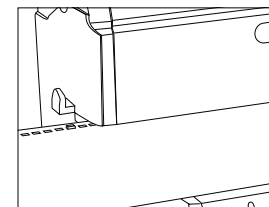

(Fig.8) From right to left, push No. 6 punched hole through the 3:1 wire registration pin, or No. 4 through the 2:1 wire registration pin. Align the paper into the **Paper entry** properly. You can do continuous punching accurately.

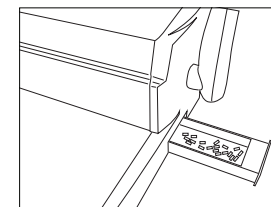

(Fig.9) Empty the **Waste tray** at the right side of the machine. Frequent clearance is required.

Wire binding

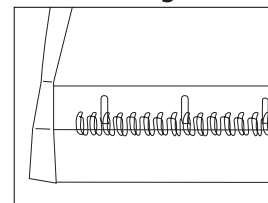

(Fig.1) Insert a wire onto the **Wire holder**.

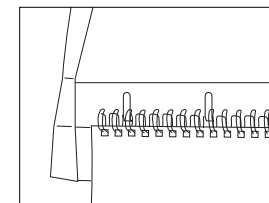

(Fig.2) Load punched sheets directly onto the wire loops.

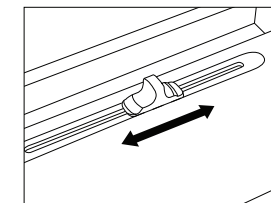

(Fig.3) Set the **Wire closer control** for the desired wire size.

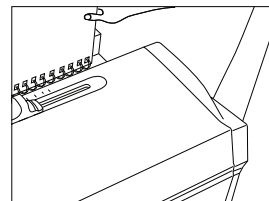

(Fig.4) Remove the booklet from the **Wire holder**. Put it down and let the wire loops rest fully into the **Wire closing channel**.

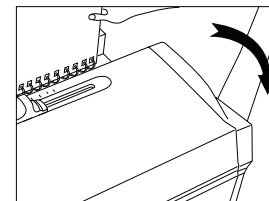

(Fig.5) Pull down the **Wire closing handle** completely to close the wire. Return it to the original position. Remove the bound booklet.

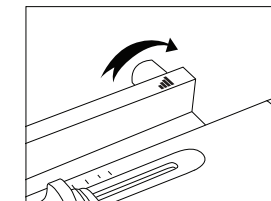

(Fig.6) Turn the **Micro adjustment knob** to refine the wire closing result. Counter clockwise to reduce the opening. Clockwise to enlarge the opening.

General Safeguards

- Place your binder on a stable surface.
- Use the machine only for its intended purpose of punching and binding paper and document covers according to the indicated specifications.
- Always test the machine with some scrap paper before punching the final document.
- Take care that there are no staples or such like in the documents to be bound.
- Empty the waste tray regularly.
- Lift the machine from the bottom, not the cover or the handle.
- Unauthorized maintenance is not allowed.